

8cm Width Pendant Ceiling LED Linear Light- Galaxy P8 Series Indoor Luminaires | Pendant | Linear Lights | Elegant & High Efficacy Linear Light



Applications

- > Hospitals And Medical Centers
- > Commercial And Entertainment Centers
- > Banks
- > Retails
- > Hotels And Restaurants
- > Offices
- > Public Buildings
- > Educational Centers
- > Airports

Benefits

- > Visual Beauty And Elegant Body Design
- > Available In Different Sizes - 50,100,150,200 [cm]
- > Uniform Illumination Using High Efficiency Opal White Polycarbonate Light Diffuser
- > Saving Energy With High Efficiency
- > Long Life Time Without High Luminous Drop During Time And Maintenance-Free
- > High Quality Light Produced By Backlight Technology

features

- > Operating Temperature (°C) : -20 ... +45
- > Lifespan : 50000 h – L80/B10
- > Efficacy (lm/w) : 100
- > Input Voltage (VAC) : 190 ... 240 | 50 ... 60 [Hz]
- > Wavelength : NO UV | NO IR

TECHNICAL DATASHEET

Electrical specifications

Power Consumption	30 [W]
Power Supply	External LED Driver
Input Voltage	190 ... 240 [VAC] – 50 ... 60 [Hz]
Energy Label	A++

Photometric data

CCT (color temperature)	3000-4000-6500 [K]
CRI (color rendering index)	> 90
Luminous Flux	3000 [lm]
Efficacy	100 [lm/w]
Beam Angle	120 °

Dimensions

Shape	Linear
Length	500 [mm]
Width	76 [mm]
Height	105 [mm]
Weight	–

Luminaire Body

Body Material	Extruded Aluminum
Body Color	All RAL Colours With Electrostatic Powder Coating
Diffuser Material	Extruded Polycarbonate
Diffuser Color	Opal White
IP Rating	44

Lifespan

lifespan	50000 h – L80/B10
warranty	3 years

Installation

Installation Type	Pendant
Usage	Pendant Ceiling Linear Lights, For General Lighting

TECHNICAL DATASHEET

Additional Systems

Dimming	Optional
DALI	Optional
Battery	Optional
Motion Sensor	Optional / External

Light Source

Manufacturing Technology	Backlight
Source Of Light	SMD LED
Module Brand	SAYAN ELECTRIC
Module Series	SE-LL5002DE2835X030A0300
Module Geometry	2 Linear Module
Chipset Brand / Package	OSRAM / DURIS® E 2835
Led Qty.	60 LEDs
Lens On Chipset	NO
Lens Type	–
Module Terminal Blocks	WAGO2060

DRIVER

Driver Type	External CC - Driver
Driver Brand	SAYAN ELECTRIC
Power Factor	> 90%
Flicker	< 20 %
THD	< 10 %
Efficiency	< 93 %
Protections	OVP-OCP-OLP-Inrush Current Protection

TECHNICAL DATASHEET

Logistics

Product Code	SE-GY8030P0501044ECO
Primary Packaging	Plastic Bag
Primary Packaging Dimensions	—
Secondary Packaging	—
Secondary Packaging Dimensions	—
Tertiary Packaging	—
Tertiary Packaging Dimensions	—
Qty. In Tertiary Packaging	—

Light Distribution Curve

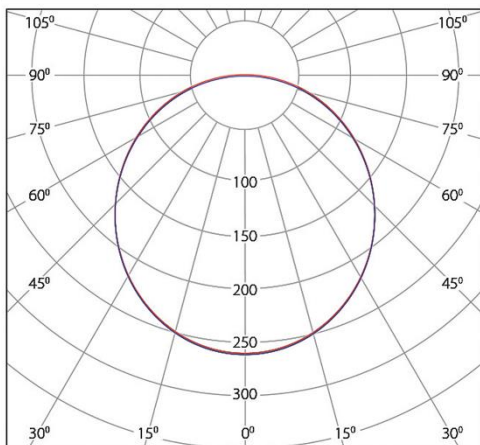

Technical Drawings

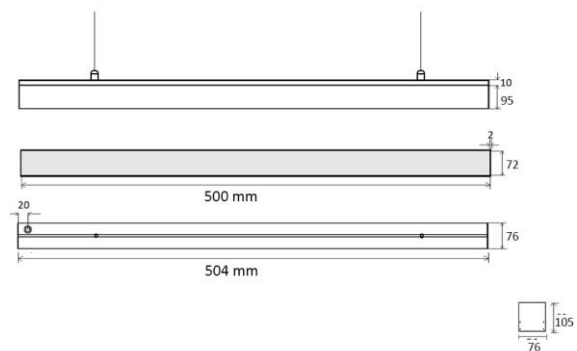

Scan QR Code For More Information